

CAP FOR D-BOX M12 8-WAY 4 POLE

No pot.-sep. 5m PUR/PVC, 8x0,34+3X0.75

Art.Nr.: 8000-88459-3620500

Vikt: 0,600 kg

Tillverknings land: CZ

Modellbeteckning: MVZ-HL 8xM12 362 5.0m

för distributionsbox 8-facks, 4-polig

Ytterligare kabellängder kan fås på begäran.

Husmaterialet är i plast med god kemisk-och oljebeständighet

Vid förekomst av aggressiv media är materialbeständighet applikationsavhängig och ska undersökas. Vidare information på begäran.

Länk till produkt

Illustration

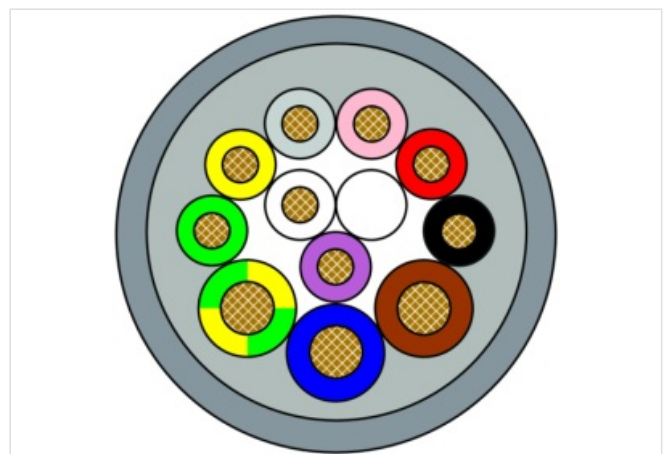
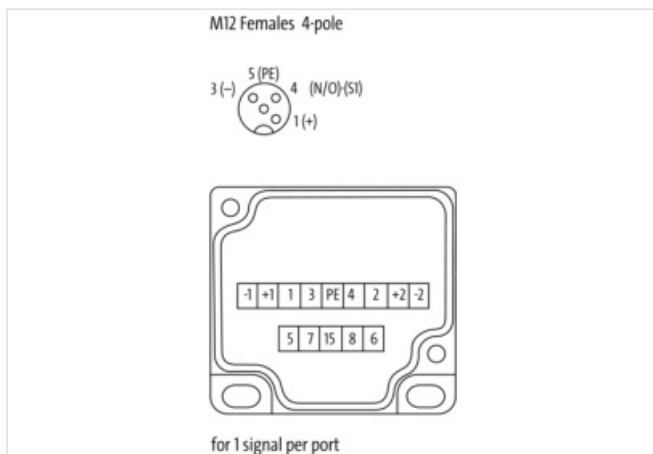
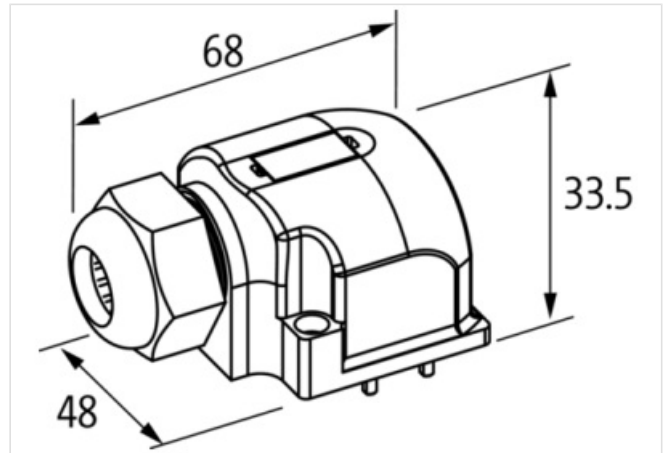

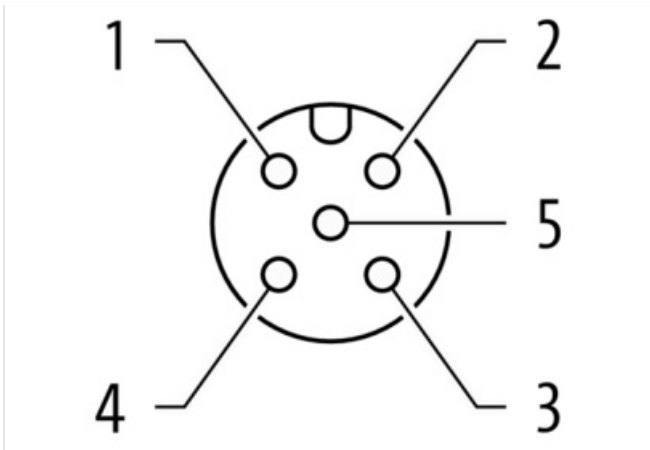

Produkten kan skilja sig från bilden



Kommersiella uppgifter

URL Webshop	https://shop.murrelektronik.com/8000-88459-3620500
GTIN	4048879054126
Customs tariff number	85444290
ECLASS-6.0	27143423
ECLASS-6.1	27279219
ECLASS-7.0	27279219
ECLASS-7.1	27279219
ECLASS-8.0	27279219
ECLASS-8.1	27279219
ECLASS-9.0	27440108
ECLASS-9.1	27440108
ECLASS-10.0.1	27440108
ECLASS-10.1	27440108
ECLASS-11.0	27440108
ECLASS-11.1	27440108
ECLASS-12.0	27440108
ECLASS-13.0	27440108
ECLASS-14.0	27440108
ETIM-5.0	EC002585
ETIM-6.0	EC002585
ETIM-7.0	EC002585
ETIM-8.0	EC002585
EAN	4048879054126
Förpackningsenhet	1
Kundens tullnummer	85444290

Electrical data | Supply

Total current max.	8 A
--------------------	-----

Device protection | Media

Flame resistance	flame retardant
------------------	-----------------

Mechanical data | Material data

Material housing	Plast
------------------	-------

Mechanical data | Mounting data

Kabellängd 5 m

Environmental characteristics | Climatic

Operating temperature min.	-20 °C
Operating temperature max.	80 °C
Additional condition temperature range	depending on cable quality

Installation | Cable

Cable identification	362
Kabeltyp	2
Function cable	Signal
Stranding	1 × 2 wires stranded with filler
Stranding (type 2)	1 × 9 wires stranded around stranding combination
Filler	Yes
Wire arrangement	(white, violet), green, yellow, gray, pink, red, black, brown, blue, green-yellow
Cable weight	105 g/m
Material wire insulation	PVC
Amount wires	8
Outer diameter insulation	1,3 mm
Outer diameter tolerance core insulation	± 0,1 mm
Shore hardness wire insulation	43 ± 5 Shore D
Material properties wire insulation	good machinability
Ingredient freeness wire insulation	lead-free, cadmium-free, CFC-free, silicone-free
Amount strands (wire)	19
Diameter of single wires	0,15 mm
Conductor crosssection (wire)	0,34 mm ²
Material conductor wire	Stranded copper wire, bare
Conductor type (wire)	Strand class 5
Material wire insulation (type 2)	PVC
Outer diameter wire insulation (type 2)	1,8 mm
Tolerance outer diameter wire insulation (type 2)	± 0,1 mm
Shore hardness wire insulation (type 2)	43 ± 5 Shore D
Material properties wire insulation (type 2)	good machinability
Ingredient freeness wire insulation (type 2)	lead-free, cadmium-free, CFC-free, silicone-free
Amount wires (type 2)	3
Amount strands wire (type 2)	24
Diameter of single wires (type 2)	0,2 mm
Conductor crosssection wire (type 2)	0,75 mm ²
Material conductor wire (type 2)	Stranded copper wire, bare
Wire conductor type (type 2)	Strand class 5
Electrical function wire (type 2)	Power
Outer-diameter (jacket)	8,1 mm
Tolerance outer diameter (sheath)	± 5 %
Material mantel	PUR
Durezza rivestimento	87 ± 5 Shore A
Freedom from ingredients (jacket)	lead-free, cadmium-free, CFC-free, silicone-free
Material property (jacket)	abrasion-resistant, low adhesion, good machinability, matte
Material inner jacket	PVC
Color (inner jacket)	grå
Conductor resistance (wire)	57 Ω/km @ 20 °C
Conductor resistance (wire type 2)	26 Ω/km @ 20 °C
Max. rated voltage (conductor - ground)	300 V
Max. rated voltage (conductor - conductor)	300 V
Withstand voltage (wire - wire)	2 kV @ 60 s

Withstand voltage (wire - jacket)	2 kV @ 60 s
Current load capacity (standard)	to DIN VDE 0298-4
Current load capacity max. (wire)	4 A
Current load capacity max. Wire (type 2)	12 A
Operating temperature min. (static)	-30 °C
Operating temperature max. (static)	80 °C
Operating temperature min. (dynamic)	-5 °C
Operating temperature max. (dynamic)	70 °C
Operating temperature min. (drag chain)	-5 °C
Operating temperature max. (drag chain)	60 °C
Flame resistance	UL 1581 § 1090, CSA FT2, IEC 60332-2-2
Oil resistance	IEC 60811-404
Chemical resistance	good
Other resistances	good resistance to gasoline, resistant to hydrolysis, resistant to microbes
Böjradie (fixerad)	5 × Outer diameter
Böjradie (vid rörelse)	10 × Outer diameter
No. of bending cycles (C-track)	2 Mio. @ 25 °C
Traversing distance (C-track)	5 m @ 25 °C
Travel speed (C-track)	2 m/s @ 25 °C
Acceleration (C-track)	10 m/s ² @ 25 °C

Connection type 2

Family construction form	free cable end
Antal poler	11
Family construction form	M12
Antal poler	4
Kodning	A
Gender	female
Color contact carrier	black
PIN 1	+
PIN 2	n.c.
PIN 3	-
PIN 4	NO S 1
PIN 5	PE