

**EXACT12, 4XM12, 5-POLE, MOULDED CABLE**

5.0m PUR/PVC 8x0,34+3X0.75, UL/CSA

Art.Nr.: 8000-84510-3630500

Vikt: 0,790 kg

Tillverknings land: DE

Modellbeteckning: MVP12N-AN4F363 5.0M

4-facks, 5-polig

Ytterligare kabellängder kan fås på begäran.

Husmaterialet är i plast med god kemisk-och oljebeständighet

Vid förekomst av aggressiv media är materialbeständighet applikationsavhängig och ska undersökas. Vidare information på begäran.

**Länk till produkt**

**Illustration**

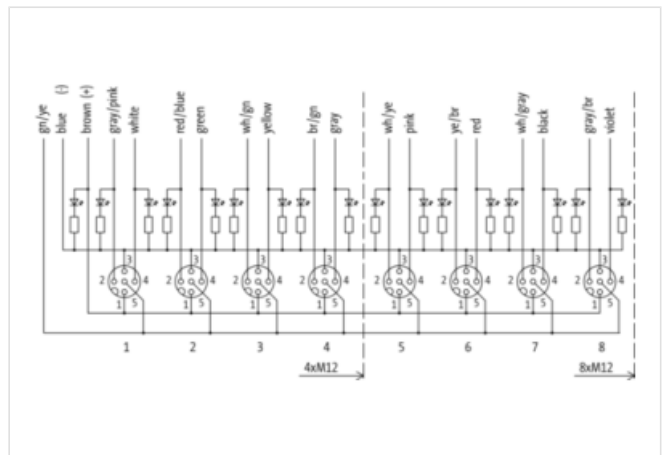
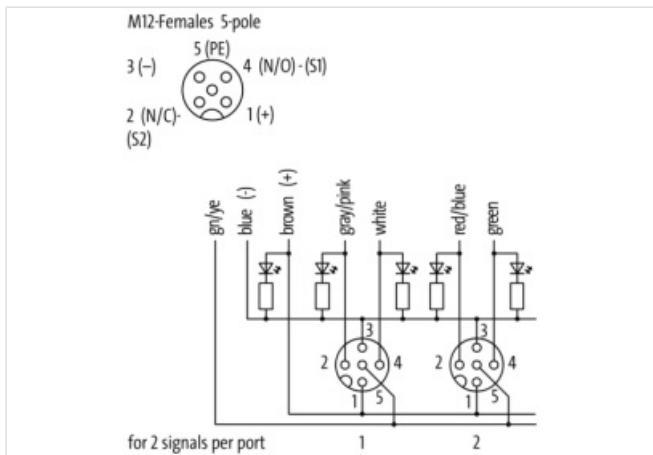
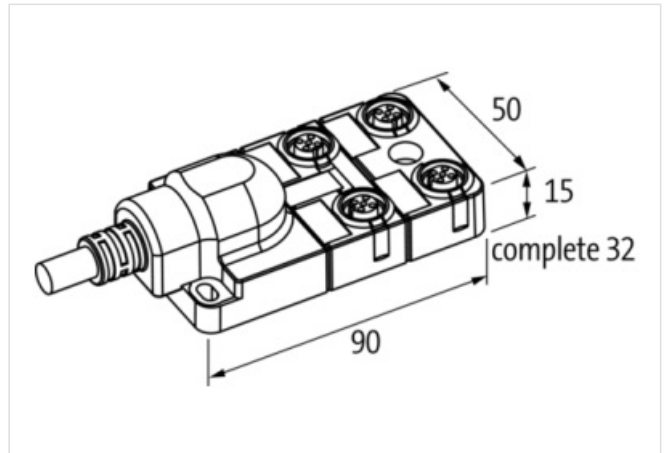

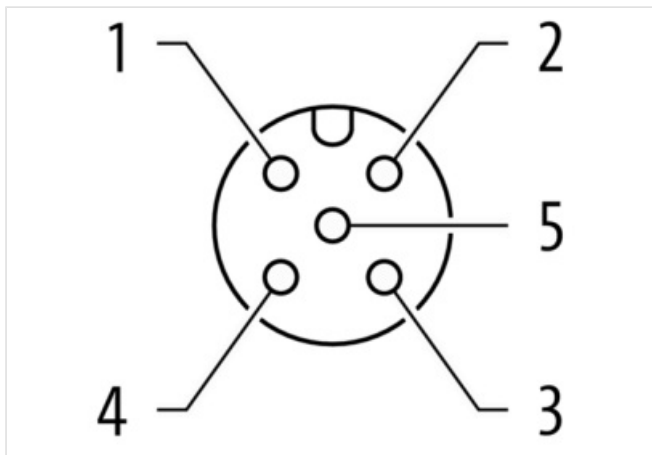
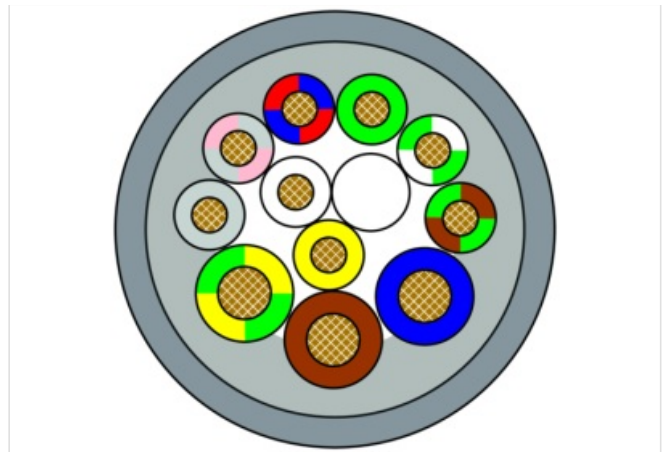
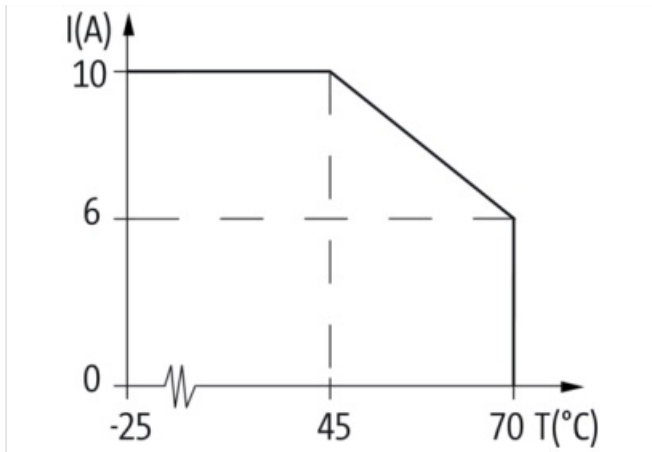

Produkten kan skilja sig från bilden



**Kommersiella uppgifter**

URL Webshop	<a href="https://shop.murrelektronik.com/8000-84510-3630500">https://shop.murrelektronik.com/8000-84510-3630500</a>
GTIN	4048879055819
Customs tariff number	85444290
ECLASS-6.0	27279219
ECLASS-6.1	27279219
ECLASS-7.0	27279219
ECLASS-7.1	27279219
ECLASS-8.0	27279219
ECLASS-8.1	27279219
ECLASS-9.0	27440108
ECLASS-9.1	27440108
ECLASS-10.0.1	27440108
ECLASS-10.1	27440108
ECLASS-11.0	27440108
ECLASS-11.1	27440108
ECLASS-12.0	27440108
ECLASS-13.0	27440108
ECLASS-14.0	27440108

ETIM-5.0	EC002585
ETIM-6.0	EC002585
ETIM-7.0	EC002585
ETIM-8.0	EC002585
EAN	4048879055819
Förpackningsenhet	1
Kundens tullnummer	85444290

**Electrical data | Supply**

Operating voltage DC	24 V
Current operating per contact max.	4 A

**Installation | Connection**

Monteringssats	M12 x 1
----------------	---------

**Device protection | Electrical**

Degree of protection (EN IEC 60529)	IP67, IP65
-------------------------------------	------------

**Device protection | Media**

Flame resistance	flame retardant
------------------	-----------------

**Mechanical data | Material data**

housing	Plast
---------	-------

**Mechanical data | Mounting data**

Monteringsmetod	Schraubgewinde
Kabellängd	5 m

**Environmental characteristics | Climatic**

Operating temperature min.	-20 °C
Operating temperature max.	70 °C
Additional condition temperature range	depending on cable quality

**Installation | Cable**

Cable identification	363
Kabeltyp	2
Function cable	Signal
Stranding	1 × 2 wires stranded with filler
Stranding (type 2)	1 × 9 wires stranded around stranding combination
Filler	Yes
Wire arrangement	(white, yellow), gray, gray-pink, red-blue, green, green-white, brown-green, blue, brown, green-yellow
Cable weight	130 g/m
Material wire insulation	PVC
Amount wires	8
Outer diameter insulation	1,3 mm
Outer diameter tolerance core insulation	± 0,1 mm
Shore hardness wire insulation	43 ± 5 Shore D
Material properties wire insulation	good machinability
Ingredient freeness wire insulation	lead-free, cadmium-free, CFC-free, silicone-free
Amount strands (wire)	19
Diameter of single wires	0,15 mm
Conductor crosssection (wire)	0,34 mm <sup>2</sup>
Material conductor wire	Stranded copper wire, bare
Conductor type (wire)	Strand class 5
Material wire insulation (type 2)	PVC
Outer diameter wire insulation (type 2)	1,8 mm
Tolerance outer diameter wire insulation (type 2)	± 0,1 mm
Shore hardness wire insulation (type 2)	43 ± 5 Shore D

Material properties wire insulation (type 2)	good machinability
Ingredient freeness wire insulation (type 2)	lead-free, cadmium-free, CFC-free, silicone-free
Amount wires (type 2)	3
Amount strands wire (type 2)	24
Diameter of single wires (type 2)	0,2 mm
Conductor crosssection wire (type 2)	0,75 mm <sup>2</sup>
Material conductor wire (type 2)	Stranded copper wire, bare
Wire conductor type (type 2)	Strand class 5
Electrical function wire (type 2)	Power
Outer-diameter (jacket)	8,1 mm
Tolerance outer diameter (sheath)	± 5 %
Material mantel	PUR
Durezza rivestimento	87 ± 5 Shore A
Freedom from ingredients (jacket)	lead-free, cadmium-free, CFC-free, silicone-free
Material property (jacket)	abrasion-resistant, low adhesion, good machinability, matte
Material inner jacket	PVC
Color (inner jacket)	grå
Conductor resistance (wire)	57 Ω/km @ 20 °C
Conductor resistance (wire type 2)	26 Ω/km @ 20 °C
Max. rated voltage (conductor - ground)	300 V
Max. rated voltage (conductor - conductor)	300 V
Withstand voltage (wire - wire)	2 kV @ 60 s
Withstand voltage (wire - jacket)	2 kV @ 60 s
Current load capacity (standard)	to DIN VDE 0298-4
Current load capacity max. (wire)	4 A
Current load capacity max. Wire (type 2)	12 A
Operating temperature min. (static)	-30 °C
Operating temperature max. (static)	80 °C
Operating temperature min. (dynamic)	-5 °C
Operating temperature max. (dynamic)	70 °C
Operating temperature min. (drag chain)	-5 °C
Operating temperature max. (drag chain)	60 °C
Flame resistance	UL 1581 § 1090, CSA FT2, IEC 60332-2-2
Oil resistance	IEC 60811-404
Chemical resistance	good
Other resistances	good resistance to gasoline, resistant to hydrolysis, resistant to microbes
Böjradie (fixerad)	5 × Outer diameter
Böjradie (vid rörelse)	10 × Outer diameter
No. of bending cycles (C-track)	2 Mio. @ 25 °C
Traversing distance (C-track)	5 m @ 25 °C
Travel speed (C-track)	2 m/s @ 25 °C
Acceleration (C-track)	10 m/s <sup>2</sup> @ 25 °C

#### Connection type 2

Family construction form	free cable end
Antal poler	11
Family construction form	M12
Antal poler	5
Kodning	A
Gender	female
Color contact carrier	black
PIN 1	+
PIN 2	NC S 2
PIN 3	-
PIN 4	NO S 1

PIN 5

PE