

**M12 female 0° D-cod. / RJ45 male 0° shielded**

PUR 1x4xAWG22 shielded gn UL/CSA+drag ch. 3m

Art.Nr.: 7000-44621-7960300

Vikt: 0,232 kg

Tillverknings land: DE

Modellbeteckning: MSRAL0-DB-T796\_3.0-ZS

Ethernet CAT5

M12 - RJ45, 4-polig

Skärmad

Husmaterialet är i plast med god kemisk-och oljebeständighet

Vid förekomst av aggressiv media är materialbeständighet applikationsavhängig och ska undersökas. Vidare information på begäran.

Ytterligare kabellängder kan fås på begäran.

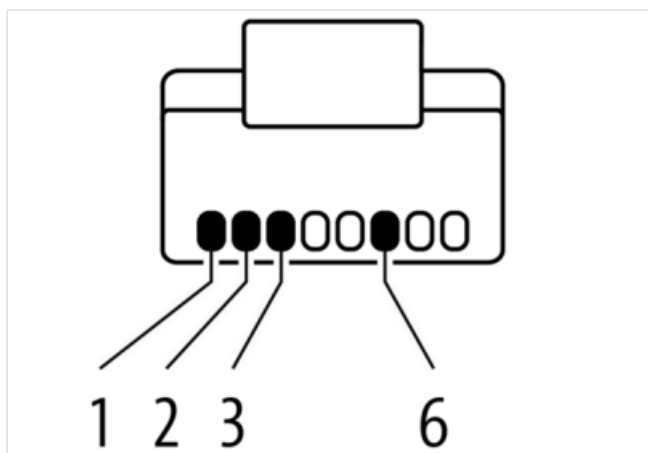
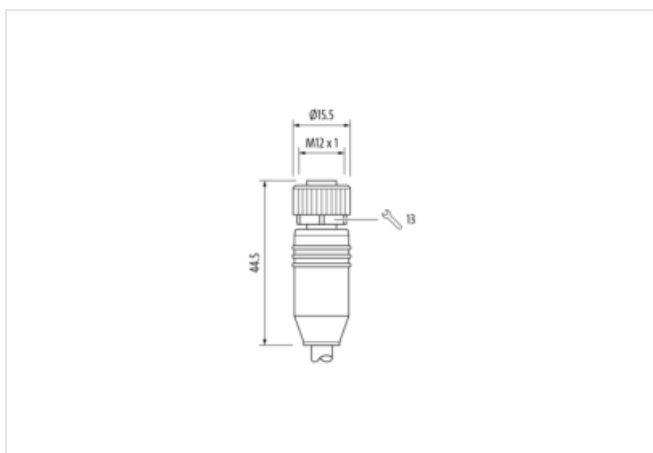
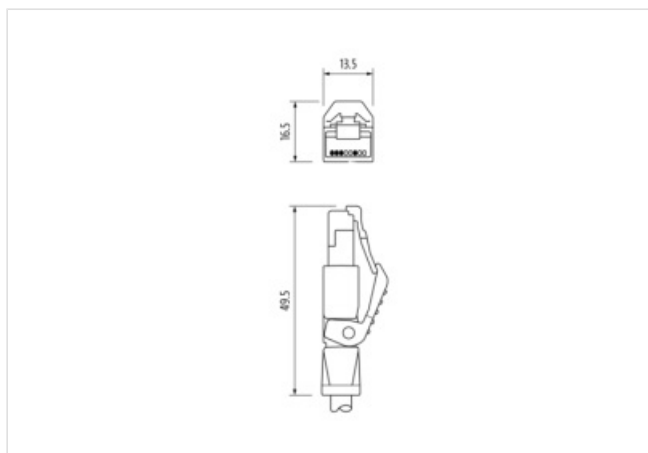
[Länk till produkt](#)**Illustration**

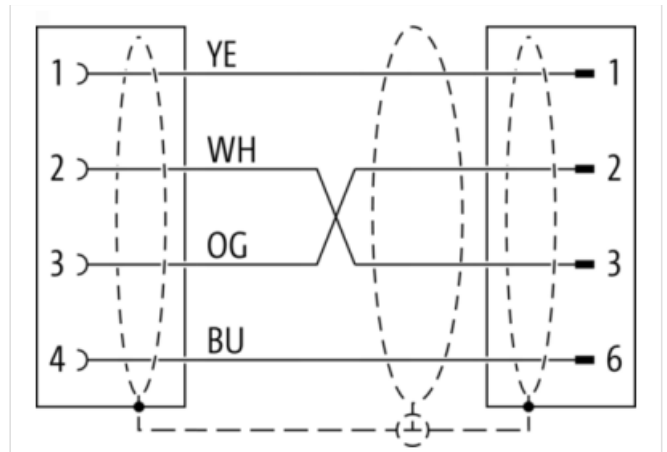
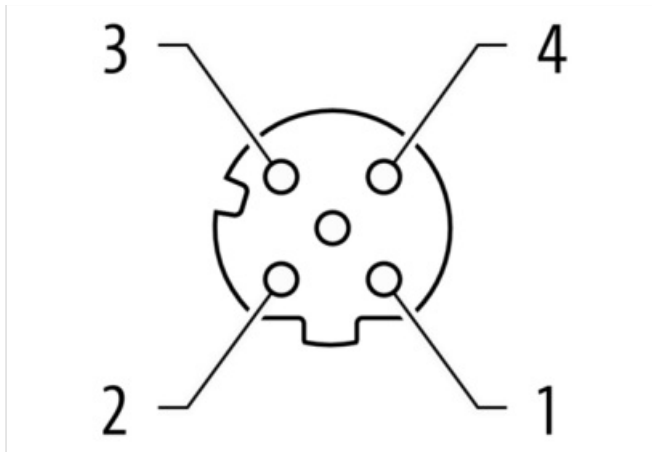

Produkten kan skilja sig från bilden



Kabellängd	3,00 m
<b>Side 1</b>	
Family construction form	M12
Antal poler	4
Kodning	D
Gender	female
Monteringsmetod	inserted, screwed
Threaded hole	M12 x 1
Tightening torque	0,6 Nm
Width across flats	SW13
Kabelanslutning	rak
Material	PUR
Material contact	Copper alloy
Coating contact	gold plated
Degree of protection (EN IEC 60529)	IP67
<b>Side 2</b>	
Family construction form	RJ45
Antal poler	4

Gender	male
Monteringsmetod	pluggable
Kabelanslutning	rak
Material	PUR
Degree of protection (EN IEC 60529)	IP20

#### Kommersiella uppgifter

URL Webshop	<a href="https://shop.murrelektronik.com/7000-44621-7960300">https://shop.murrelektronik.com/7000-44621-7960300</a>
GTIN	4048879704588
ECLASS-6.0	27061801
ECLASS-6.1	27060307
ECLASS-7.0	27060307
ECLASS-7.1	27060307
ECLASS-8.0	27060307
ECLASS-8.1	27060307
ECLASS-9.0	27060307
ECLASS-9.1	27060307
ECLASS-10.0.1	27060307
ECLASS-10.1	27060307
ECLASS-11.0	27060307
ECLASS-11.1	27060307
ECLASS-12.0	27060307
ECLASS-13.0	27060307
ECLASS-14.0	27060307
ETIM-5.0	EC002599
ETIM-6.0	EC002599
ETIM-7.0	EC002599
ETIM-8.0	EC002599
EAN	4048879704588
Förpackningsenhet	1
Kundens tullnummer	85444290

#### Electrical data | Supply

Operating voltage DC max.	60 V
Current operating per contact max.	1,5 A

#### Industrial Communication

Data transmission rate max.	100 Mbit/s
Överföringsparametrar	CAT5, Class D (ISO/IEC 11801:2002), (EN 50173-1)

#### Industrial communication | Ethernet functionality

duplex	Full duplex
--------	-------------

#### Device protection | Electrical

Additional condition protection degree	inserted, screwed
Försmutningsgrad	3
Rated surge voltage	1 kV
Material group (IEC 60664-1)	I

#### Mechanical data

Contour for corrugated hose	utan
-----------------------------	------

#### Mechanical data | Material data

Material screw connection	Zinc die-casting
Coating of fitting	nickel plated
Låsningmaterial	PA
Material guarnizione	FKM

#### Environmental characteristics | Climatic

Operating temperature min.	-30 °C
Operating temperature max.	85 °C
Additional condition temperature range	depending on cable quality

#### Important installation notes

Note on bending radius	<b>Attention:</b> Observe the permissible bending radii when laying cables, as the IP protection class can be endangered by excessive bending forces.
Note on strain relief	Protect the connectors by suitable measures from mechanical loads, e.g. by the usage of cable ties.

#### Conformity

Product standard	EN IEC 61076-2-101 (M12), EN IEC 60603-7 (RJ45)
------------------	---

#### Installation | Cable

Cable identification	796
Function cable	Data
Stranding	1 × 4 wires around core filler star-shaped twisted
Cable shielding (type)	copper braid, tinned
Cable shielding (coverage)	85 %
Banding	Foil, Fleece
Filler	Yes
Wire arrangement	white, yellow, blue, orange
Cable weight	63 g/m
Material wire insulation	PE
Amount wires	4
Outer diameter insulation	1,4 mm
Outer diameter tolerance core insulation	± 0,05 mm
Shore hardness wire insulation	65 ± 5 Shore D
Ingredient freeness wire insulation	halogenfri
Amount strands (wire)	7
Diameter of single wires	30 AWG
Conductor crosssection (wire)	22 AWG
Material conductor wire	Stranded copper wire, bare
Outer-diameter (jacket)	6,7 mm
Tolerance outer diameter (sheath)	± 5 %
Material mantel	PUR
Durezza rivestimento	89 ± 5 Shore A
Freedom from ingredients (jacket)	halogenfri
Material property (jacket)	abrasion-resistant, low adhesion, good machinability, matte
Material inner jacket	FRNC
Color (inner jacket)	natural
Conductor resistance (wire)	55.4 Ω/km @ 20 °C
Electrical capacity line constant (wire - wire)	50.000 pF/km
Isolationsmotstånd	5.000 MΩ × km
Nominal voltage max.	300 V
Withstand voltage (wire - wire)	2 kV @ 60 s
Withstand voltage (wire - jacket)	2 kV @ 60 s
Withstand voltage (wire - shield)	2 kV @ 60 s
Current load capacity (standard)	to DIN VDE 0298-4
Current load capacity max. (wire)	4,8 A
Characteristic impedance	100 Ω ± 15 %
Operating temperature min. (static)	-40 °C
Operating temperature max. (static)	80 °C
Operating temperature min. (dynamic)	-30 °C
Operating temperature max. (dynamic)	70 °C
Operating temperature min. (drag chain)	-30 °C
Operating temperature max. (drag chain)	70 °C

Flame resistance	IEC 60332-1-2, UL 1581 § 1090, UL 1581 § 1100
Oil resistance	IEC 60811-404, IRM 901, NEMA WC55
Ozone resistance	IEC 60811-403
UV resistance	UL 1581 § 1200
Other resistances	resistant to hydrolysis, resistant to microbes, MUD-resistant (NEK 606)
Böjradie (fixerad)	5 × Outer diameter
Böjradie (vid rörelse)	12 × Outer diameter
No. of bending cycles (C-track)	3 Mio. @ 25 °C
Traversing distance (C-track)	5 m @ 25 °C
Travel speed (C-track)	3.3 m/s @ 25 °C
Acceleration (C-track)	2 m/s <sup>2</sup> @ 25 °C
No. of torsion cycles	1 Mio. @ 25 °C
Torsion stress	± 180 °/m
Torsion speed	35 cycles/min