

MST 1-PHASE CONTROL AND ISOLATION TRANSFORMER

P: 1600VA IN: 208...550VAC OUT: 2x115VAC

Art.Nr.: 86152

Vikt: 20,000 kg

Tillverknings land: CZ

Modellbeteckning: MST 1600-208...550/2x115

Enfas styrl- och isolertransformator

1600 VA

Isolationsklass T 40/B

Andra spänningar på begäran.

Länk till produkt

Illustration

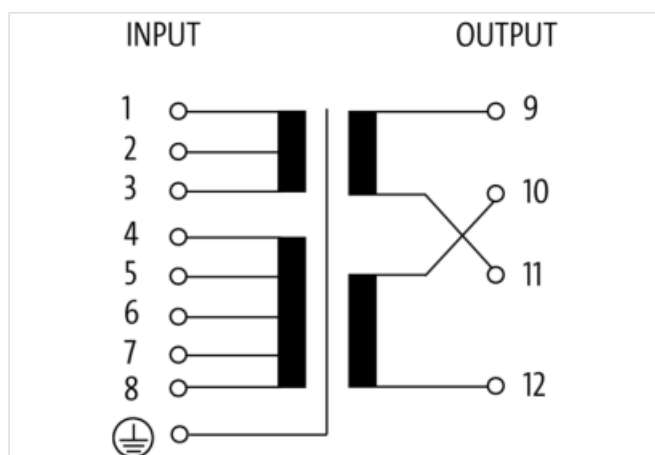
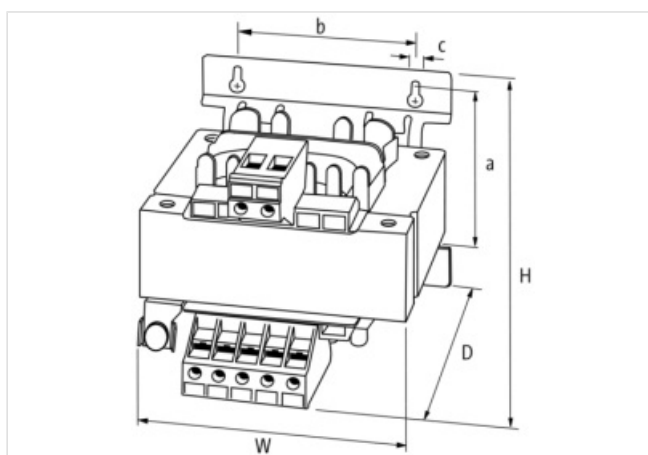

Produkten kan skilja sig från bilden



Kommersiella uppgifter

URL Webshop <https://shop.murrelektronik.com/86152>

GTIN 4048879078719

Customs tariff number 85043200

ECLASS-6.0	27031302
ECLASS-6.1	27031302
ECLASS-7.0	27031302
ECLASS-7.1	27031302
ECLASS-8.0	27031302
ECLASS-8.1	27031302
ECLASS-9.0	27031302
ECLASS-9.1	27031302
ECLASS-10.0.1	27031302
ECLASS-10.1	27031302
ECLASS-11.0	27031302
ECLASS-11.1	27031302
ECLASS-12.0	27031302
ECLASS-13.0	27031302
ECLASS-14.0	27031302
ETIM-5.0	EC002486
ETIM-6.0	EC002486
ETIM-7.0	EC002486
ETIM-8.0	EC002486
EAN	4048879078719
Förpackningsenhet	1
Kundens tullnummer	85043200

Electrical data | Supply

Power frequency	50 ... 60 Hz
-----------------	--------------

Electrical data | Input

Input voltage AC	420, 208, 525, 550, 230, 380, 400, 440, 460, 480, 500
Nominal input voltage AC	208 V ... 550 V
Nominal current AC	8.8 A @ 208 V, 3.3 A @ 550 V
Inrush current at input voltage 1	182 A
Inrush current at input voltage 2	70 A
Short-circuit current at input voltage 1	460 A
Short-circuit current at input voltage 2	175 A

Electrical data | Output

Output voltage adjustable	Yes
Utgångsspänning	1 × 230 / 1 × 115 / 2 × 115 V AC
Output voltage AC 1	230 V
Output voltage AC 2	115 V
Power rating AC max.	1.600 VA

Device protection | Electrical

Insulation test voltage input - output	4 kV
--	------

Mechanical data | Mounting data

Height	168 mm
Width	174 mm
Depth	163 mm
Suitable for mounting type	Keyhole mounting
Mounting dimension a	141 mm
Mounting dimension b	135 mm
Mounting dimension c	7 mm
Diameter bore	7 mm
Length bore	11 mm

Environmental characteristics | Climatic

Operating temperature min.	-20 °C
----------------------------	--------

Operating temperature max.	40 °C
Ambient temperature (storage, transport)	-20 °C ... 80 °C

Conformity

Product standard	EN IEC 61558-1, EN IEC 61558-2-4
------------------	----------------------------------

Connection type 5

Connection type 1	Ingång
Connection type 2	Ingång
Connection type 3	Output
Connection type 4	Output
Family construction form	terminal
Antal poler	8
Gender	female
Anslutning	Screw terminals SK
PIN 1	1
PIN 2	2
PIN 3	3
PIN 4	4
PIN 5	5
PIN 6	6
PIN 7	7
PIN 8	8
Family construction form	terminal
Antal poler	8
Gender	female
Anslutning	Plug-in terminals RK
PIN 1	1
PIN 2	2
PIN 3	3
PIN 4	4
PIN 5	5
PIN 6	6
PIN 7	7
PIN 8	8
Family construction form	terminal
Antal poler	4
Gender	female
Anslutning	Screw terminals SK
PIN 1	9
PIN 2	10
PIN 3	11
PIN 4	12
Family construction form	terminal
Antal poler	4
Gender	female
Anslutning	Plug-in terminals RK
PIN 1	9
PIN 2	10
PIN 3	11
PIN 4	12
Family construction form	terminal
Antal poler	1
Gender	female
Color contact carrier	metallic

Anslutning

Screw terminals SK

PIN 1

PE